



Pools up to 110m³ max.
Max. length : 12m

Equipment

- A** Removable lid with mechanical lock
- B** Filtration (auto and manual) and lighting controls.
- C** In-ground-section containing :
 - Filter pump (25 m³/h)
 - **Salt chlorinator**, consisting of reverse polarity cell and electronic unit for automatic treatment.
- D** Two removable filter cartridges with leaf baskets
- E** Balneotherapy (air control dial)
- F** Skimmers, two water suction inlets
- G** Multi-directional, high-volume return nozzle
- H** White LED spotlight + Remote control
> Colour optional

INTEGRABLE OPTIONS :

- Counter-current system



Schematic diagram

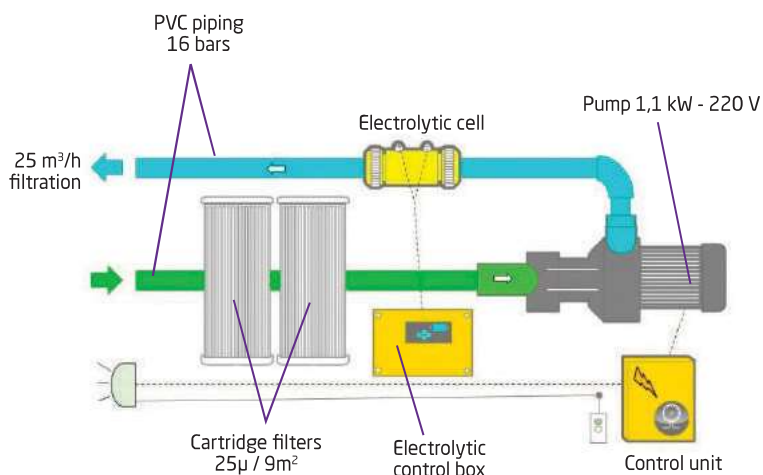

MX Dimensions

